

Product Specifications

Customer	
Model Name	NTWP215-6 V502E
Model Number	NTWP215H<u>X6XX</u>-GI<u>XX8XX</u>-<u>XXFX</u>-502E

* X = A~Z, 0~9 (Depends on Options.)



Records of Revision			
Vision	Modifying	Old Description	New Description
v2407.1	Preliminary Specification		

Nextech WP Series 21.5" All-in-one Industrial Touch PC

NTWP215-6 V502E

Features

- ★ 21.5 inch Industrial Grade Panel, 1920x1080 (FHD) Resolution
- ★ 1500nits High Brightness
- ★ Wide Viewing Angle Technology , 178°/178°
- ★ Intel® Quad-Core N3350/N4200 CPU
- ★ DDR3 8G DRAM
- ★ Narrow Bezel, True Flat Projected Capacitive Touch Screen
- ★ 7H Hardness Tempered Cover Glass
- ★ 10 points Multi-touch, Supports NEXTECH Dedicated Stylus
- ★ Metal Cabinet with Diverse Combine Options
- ★ Made in Taiwan, 3 Years Warranty, Designed for Harsh Environments
- ★ Optional Anti-Glare&UV/Antibacterial/Privacy Filter Surface Treatment



PSE



BSMI



RoHS



CE



ISO9001



FCC



Desktop Stand



Wall Mounting



Open-frame Brackets

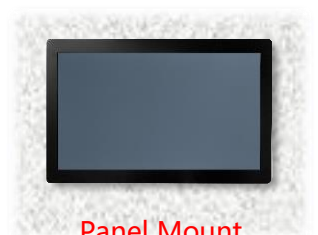

Panel Mount

System Specifications

CPU	Intel® Celeron/Pentium Processor
Memory	DDR3 SO-DIMM 8G
Storage	SATAx1, M.2 M-key (SATA 6Gb/s) x1, Full-size Mini PCIe Slot x1
GPU	Intel® HD Graphics 500
Sound Chip	Realtek® Audio CODEC
Network	Intel® i211AT Gbe LAN Chips x2

Display Specifications

Screen Diagonal	21.5 inch	Display Mode	Normally Black
Display Area	476.6x268.1 mm	Backlight Unit	LED (white LED)
Resolution	1920x1080 (FHD)	Viewing Angle (L/R, U/D)	178°/178° (CR=10)
Contrast Ratio	1000:1	Response Time	14 msec.
Display Ratio	16:9	Backlight Lifetime	>30,000 Hours
Support Colors	16.7M Colors	Operating Temp.	-20~70°C
Pixel Pitch	0.24825x0.24825 mm	Storage Temp.	-30~80°C
Brightness	1500nits		

Touch Options

Touch Screen		
	Description	Model Name
Standard	Projected Capacitive Touch	NTWP215HP6XX-GIXX8XX-XXFX-502E
Option 1	Resistive Touch	NTWP215X5SXX-GIXX8XX-XXXX-502E
Option 2	Non-Touch	NTWP215X0SXX-GIXX8XX-XXXX-502E

Projected Capacitive

Touch Technology	Projected Capacitive	Thickness of Cover Lens	2.0±0.2mm
Allowed Touch Points	10 points	Hardness of Cover Lens	7H
Transparency	≥87%	IK Ratings	IK07
Accuracy	99.00%		

Resistive Touch

Touch Technology	Resistive Touch	Transparency	80%±5%
Allowed Touch Points	1 point	Surface Treatment	Anti-glare<15%
Precision	98.50%	Hardness	≥3H

Surface Treatment		
	Description	Model Name
Standard	(none)	NTWP215HX600-GIXX8XX-XXFX-502E
Option 1	Anti-Glare&UV Coating	NTWP215HX6GG-GIXX8XX-XXFX-502E
Option 2	Antibacterial (AB Film)	NTWP215HX6AB-GIXX8XX-XXFX-502E
Option 3	Anti-Spy (AS Film)	NTWP215HX6SF-GIXX8XX-XXFX-502E

Passive Stylus Pen (Option)	
Technology	Passive High Sensitive Knitted Wire Mesh Fiber Tip
Size of tip	6mm
Magnetic Attachment	Yes

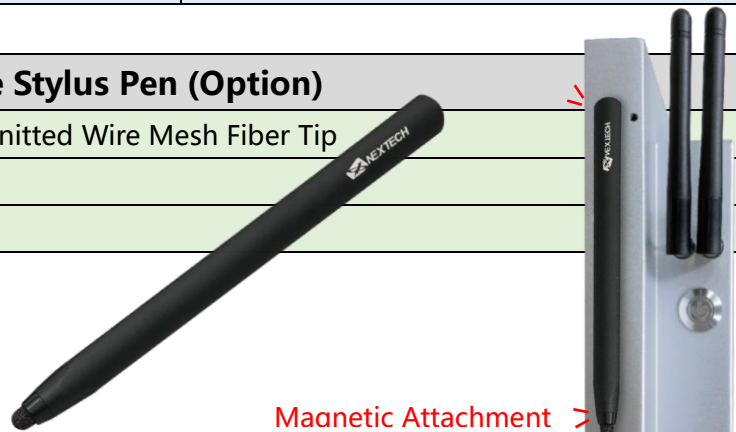

Magnetic Attachment >

System Options

CPU		
	Item	Model Name
Standard	N3350	NTWP215HX6XX-GIC18XX-XXFX-502E
Option	N4200	NTWP215HX6XX-GIC28XX-XXFX-502E

Storage		
	Item	Model Name
Standard	SSD 128G	NTWP215HX6XX-GIXX8S1-XXFX-502E
Option 1	SSD 256G	NTWP215HX6XX-GIXX8S2-XXFX-502E
Option 2	SSD 512G	NTWP215HX6XX-GIXX8S3-XXFX-502E
Option 3	SATA HDD 1T	NTWP215HX6XX-GIXX8H1-XXFX-502E
Option 4	SSD 128G + SATA HDD 1T	NTWP215HX6XX-GIXX8SH-XXFX-502E

Material of Cabinet		
	Description	Model Name
Standard	SECC	NTWP215HX6XX-GIXX8XX-SXFX-502E
Option 1	Stainless Steel	NTWP215HX6XX-GIXX8XX-LXFX-502E
Option 2	Aluminum	NTWP215HX6XX-GIXX8XX-AXFX-502E

System Options (Continued)

Color of Cabinet		
	Description	Model Name
Standard	Silver	NTWP215HX6XX-GIXX8XX-<u>X</u>SFX-502E
Option 1	White	NTWP215HX6XX-GIXX8XX- <u>X</u> WFX-502E
Option 2	Black	NTWP215HX6XX-GIXX8XX- <u>X</u> BFX-502EE
Options	Other Colors	NTWP215HX6XX-GIXX8XX- <u>X</u> FX-502E

* X = A~Z, 0~9 (Depends on Color)

Power Input		
	Description	Model Name
Standard	9~36VDC-in, with AC/DC Adapter	NTWP215HX6XX-GIXX8XX-<u>XX</u>F<u>4</u>-502E
Option	100~240V AC, C14 AC Power Socket	NTWP215HX6XX-GIXX8XX- <u>XX</u> F <u>A</u> -502E



DC-in



AC-in

Input /Output System

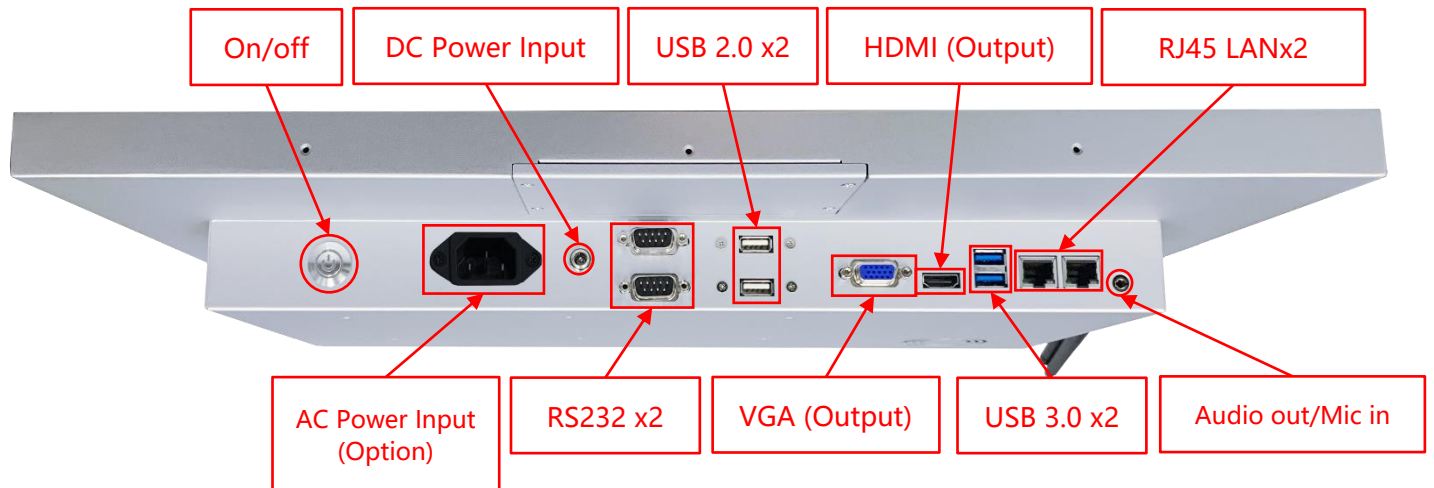

Nextech WP Series 21.5" All-in-one Industrial Touch PC

NTWP215-6 V502E

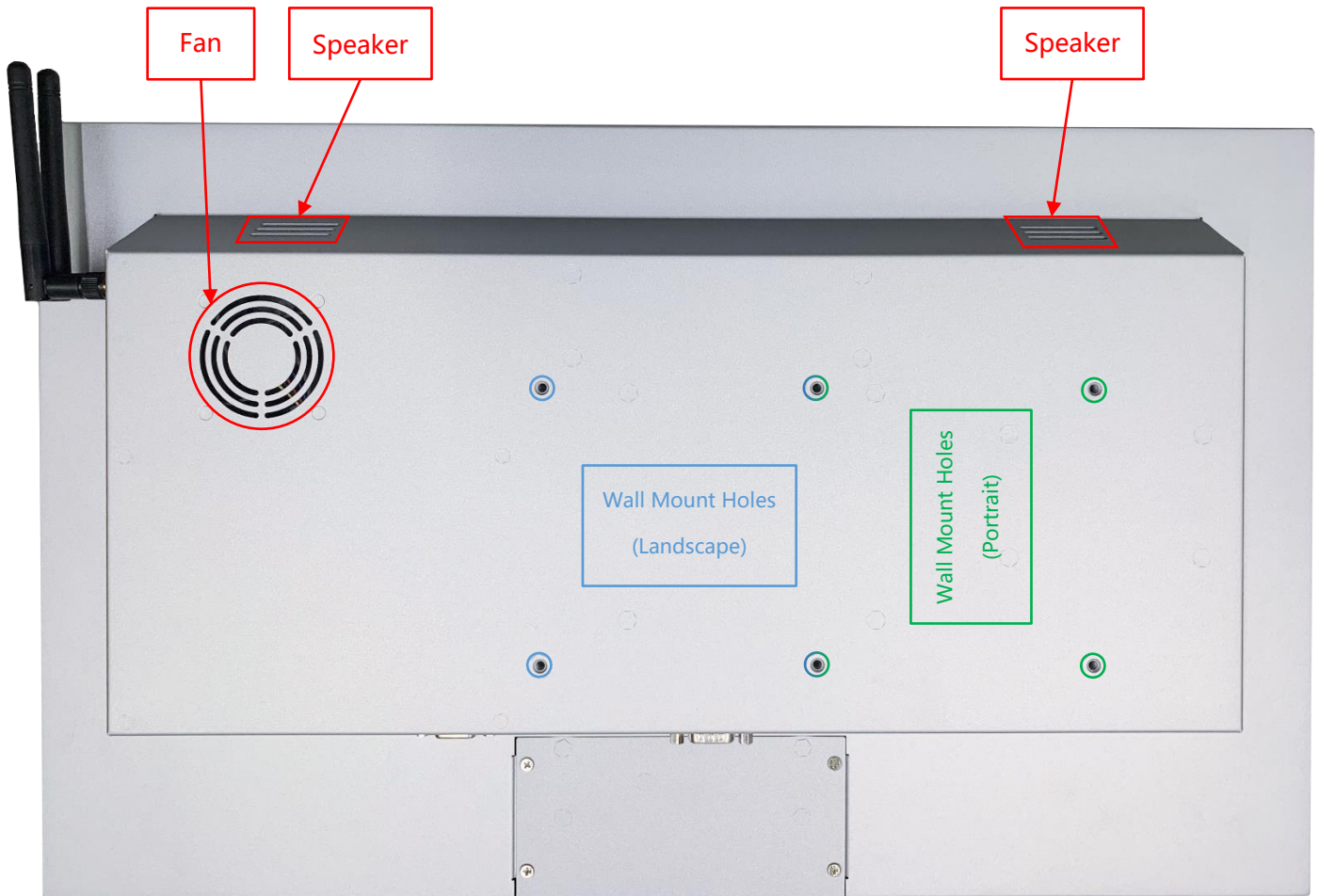

Input / Output	Connectors	Input / Output	Connectors
HDMI (Output)	1	USB 3.0	2
VGA (Output)	1	USB 2.0	2
Audio Output /Mic Input (3.5mm)	1	RS232	2
DC Power Input	1	LAN (RJ45)	2
AC Power Input	Option	Wi-Fi/Bluetooth & Antenna	Option
Speakers	2W x2		

Front Cover (Option)

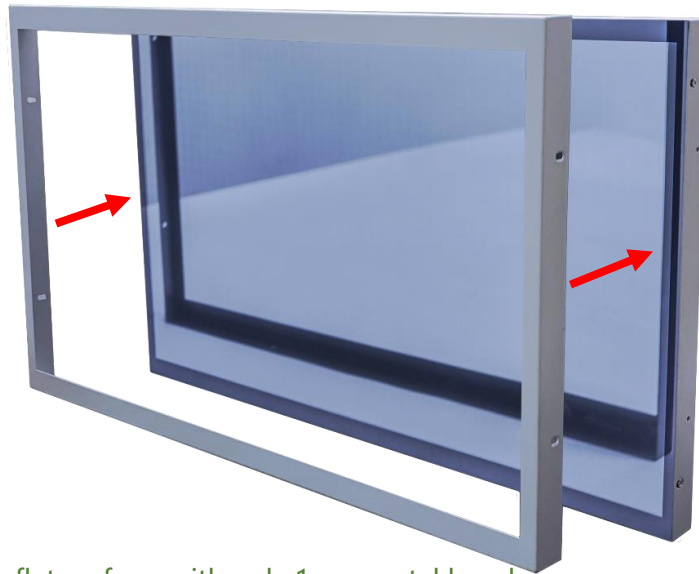

The standard **NTWP215** is true flat surface, with only 1mm metal bezel.
To protect the corners of the touch screen, the **Front Cover** can be added.



The watertight gasket can be added between the **Front Cover** and **NTWP215**.
It complies **IP65** on front.

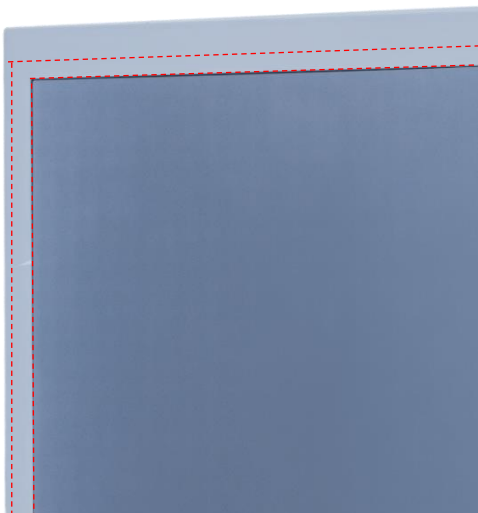

Open-frame Brackets (Option)

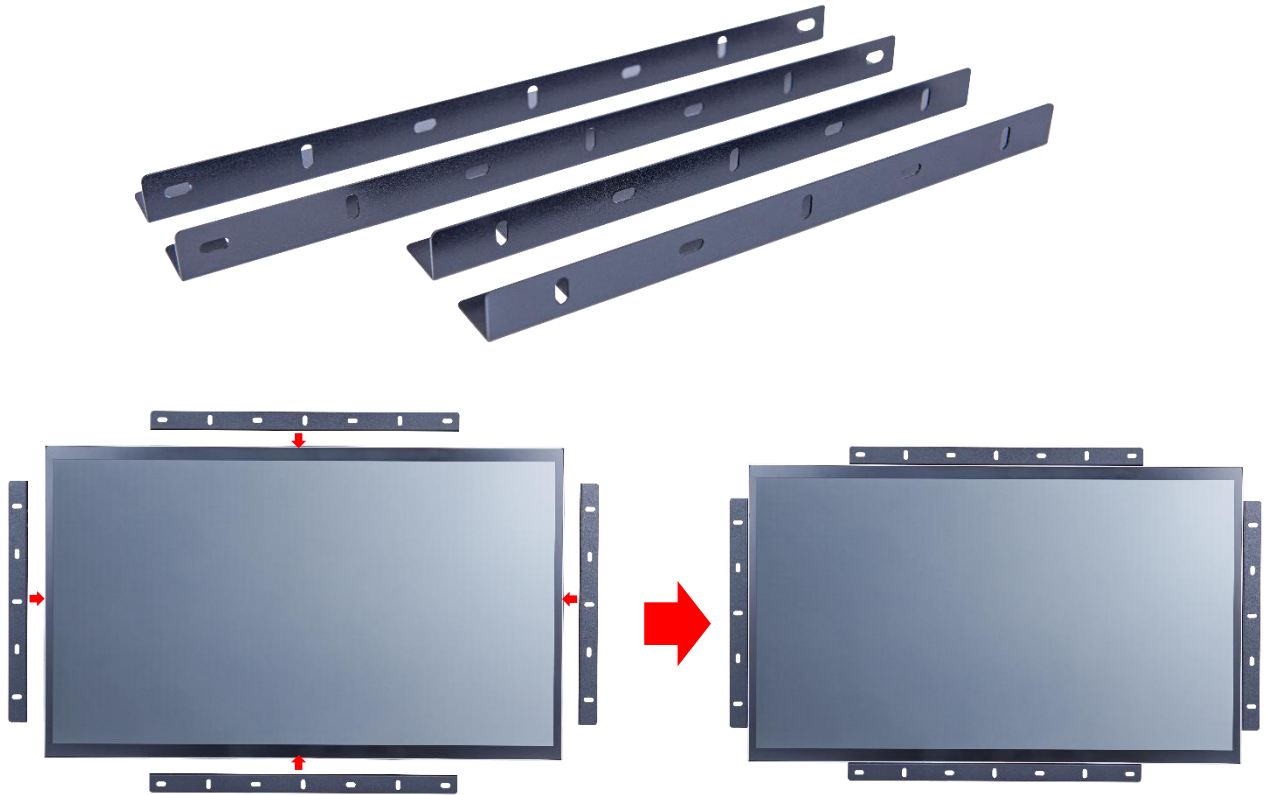

Dimension for Installing with Open-frame Brackets

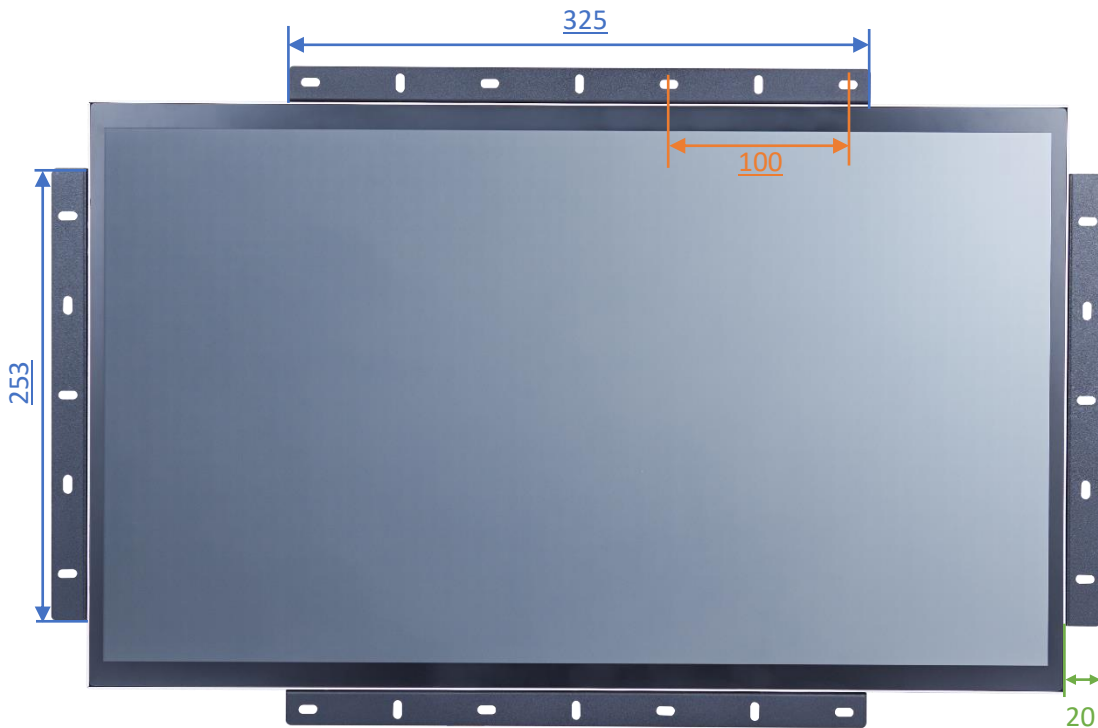

Panel Mount Kits (Option)

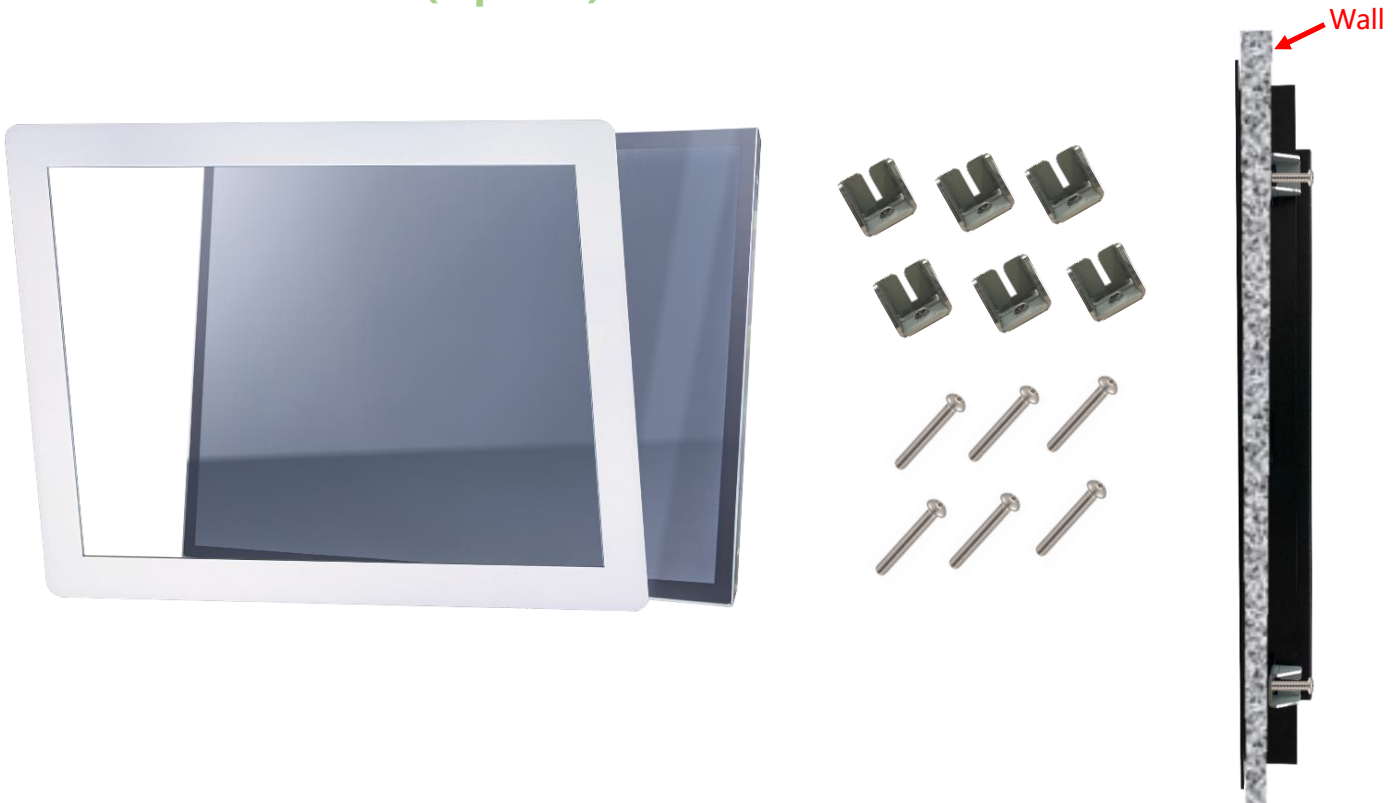

Dimension for Installing with Panel Mount Kits

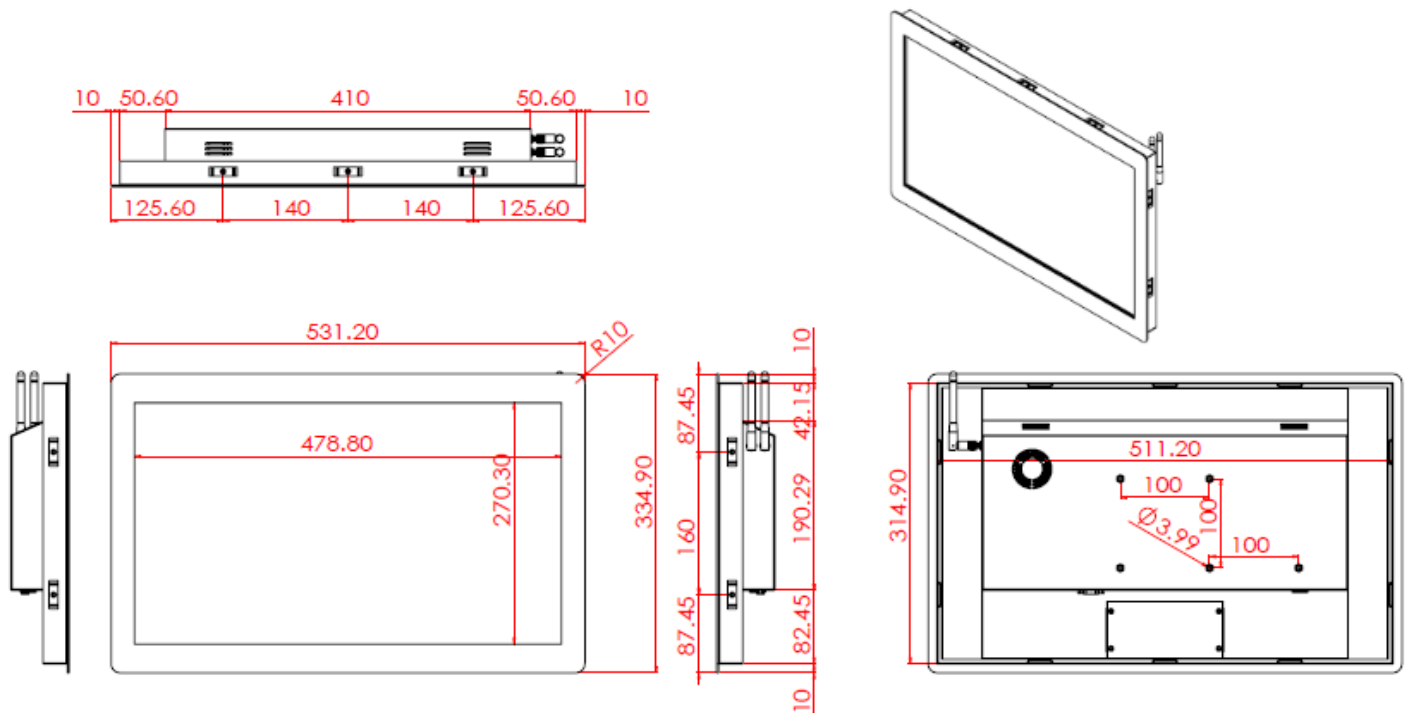

Nextech WP Series 21.5" All-in-one Industrial Touch PC

NTWP215-6 V502E

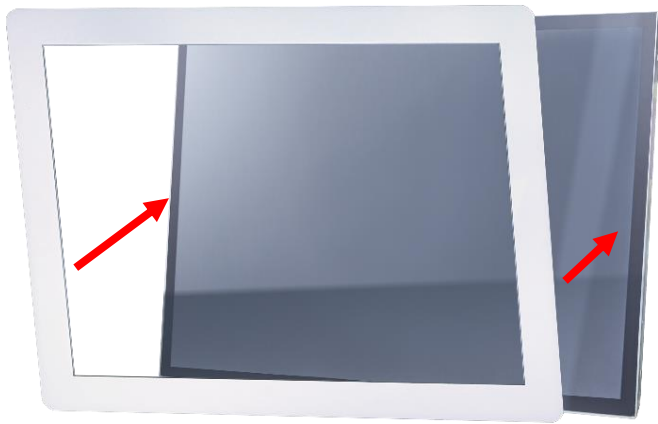

Step 1: Assemble the front module with the screen body. (This step is pre-assembled at the factory.)

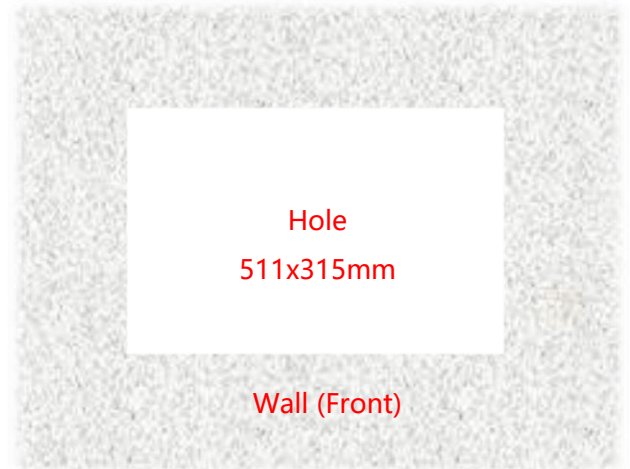

Step 2: Insert the screen from the front into the pre-cut opening.

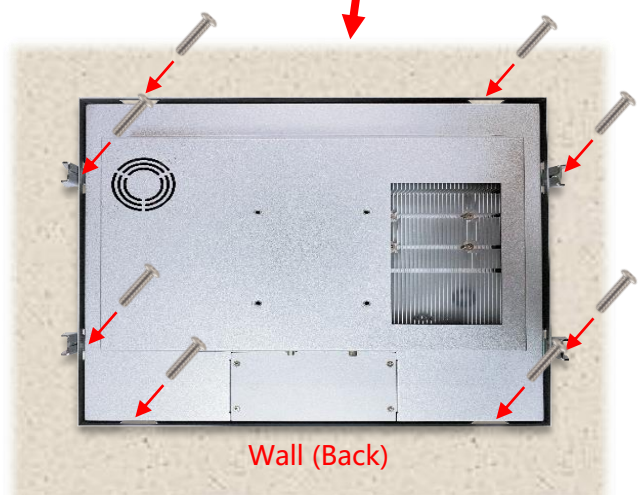
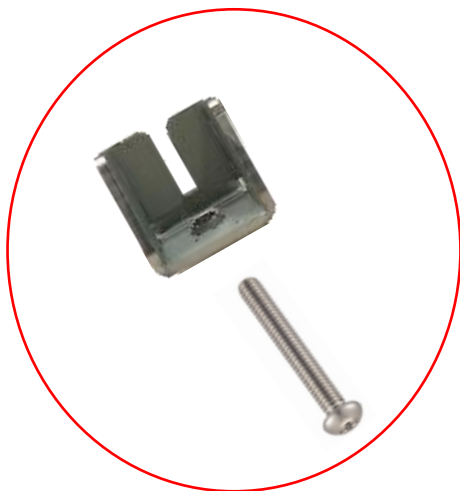

Step 3: Attach the clips from the back and secure with screws. (Up to 10 clips can be installed as needed or per positional limitations.)

Nextech WP Series 21.5" All-in-one Industrial Touch PC

NTWP215-6 V502E

Desktop Stand (Option)

Item	B Stand	Part No.	DST-0B002/DST-1B002
Mounting Pattern	100x100 / 75x75 mm	Dimension (WxHxD)	203x275x227 mm
Material	Steel/Plastic/Aluminum	Net Weight	1.8 KG
Tilt (Hinge)	-2° ~ +180°	Support Max. Weight	15 KG



Item	Z Stand	Part No.	DST-0BZ01/DST-1BZ01
Mounting Pattern	100x100 / 75x75 mm	Dimension (WxHxD)	190x240x41.6
Material	SECC	Net Weight	2.6 KG
Tilt (Hinge)	±360°	Support Max. Weight	15 KG



Wall Mount Bracket (Option)

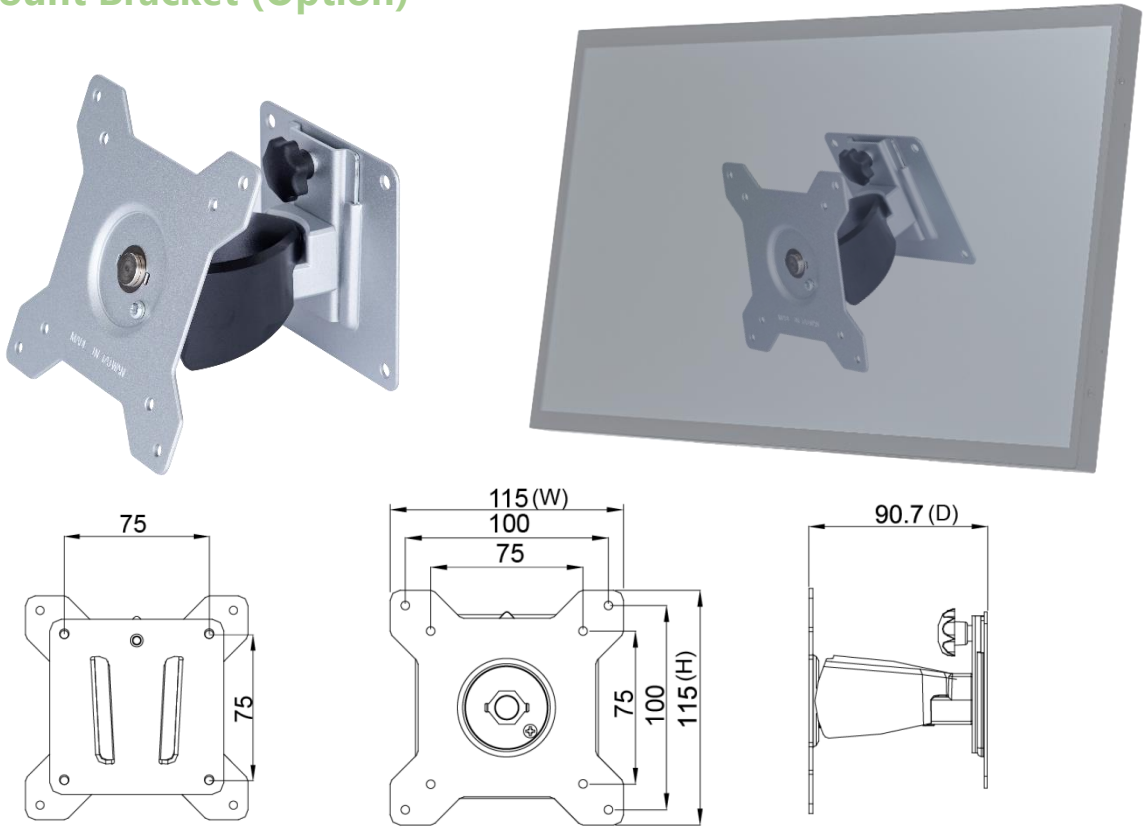

Packing Information



Unit Carton Size	670x155x445 mm
Unit N. Weight	≤5.1 KG
Unit G. Weight	≤7.2 KG
Units per Pallet	30 units
Pallet Size	120x100x147 CM

Physical Specifications

Dimension	501x305x62(±2)mm	Net Weight	≤5.1 KG
VESA Mounting	100x100 mm	Gross Weight	≤7.2 KG

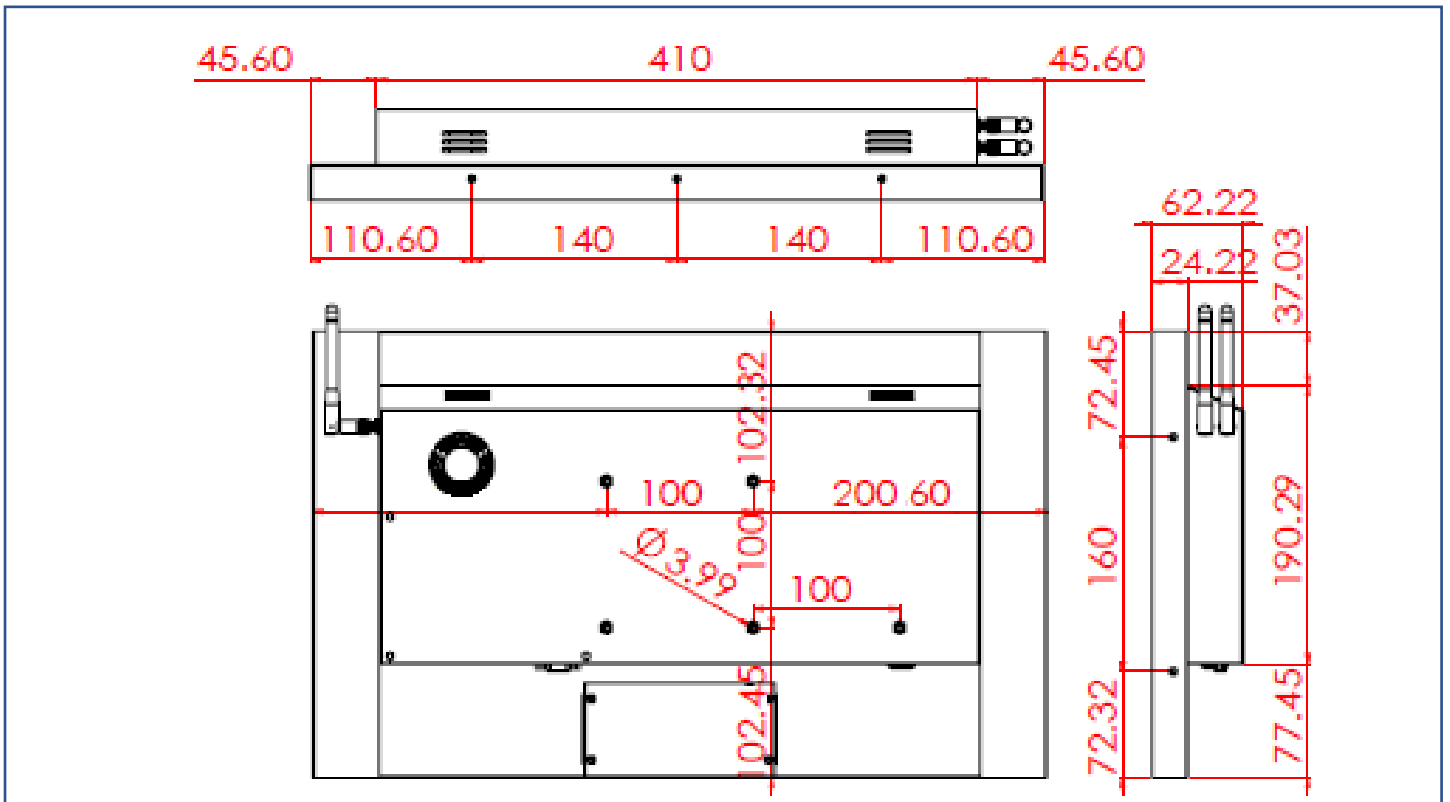
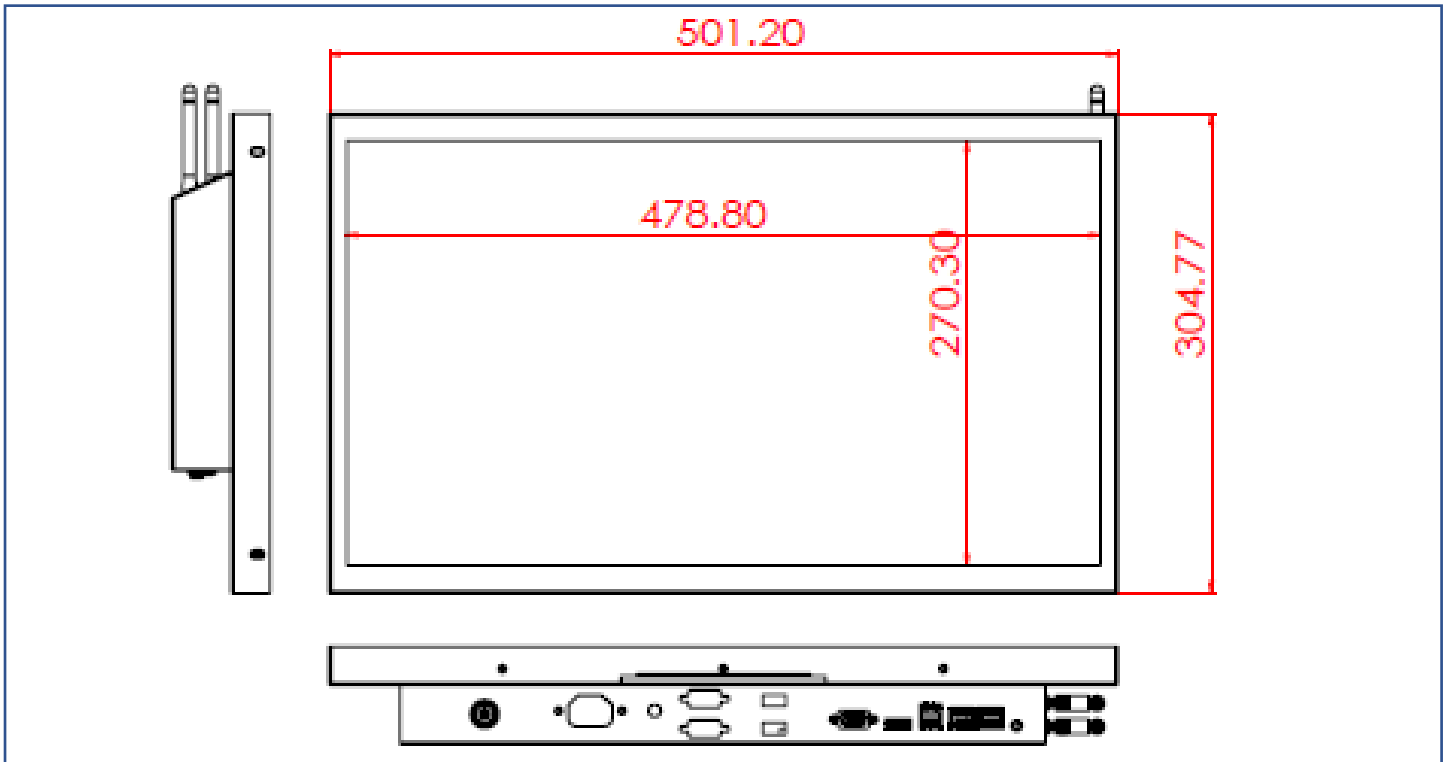

Cosmetic Inspection Standard

Display Area Allowance			
Defect description	Defective Specifications	Allowance	Remarks
Dot Defect (including dark dot, particles, bubbles, pits, dust, foreign matter)	$D \leq 0.2\text{mm}$	Ignored	D=Diameter
	$0.2 < D \leq 0.7\text{mm}$	$N \leq 5$	N=Quantity
	$0.7 < D \leq 1\text{mm}$	$N \leq 3$	
	$D > 1\text{mm}$	$N \leq 0$	
Linear Defect (including scratches, fluff, particles)	$W \leq 0.15\text{mm}$	Ignored	W=Width
	$0.15 < W \leq 0.5\text{mm}, L \leq 15\text{mm}$	$N \leq 2$	L=Length
	$W > 0.5\text{mm}$ or $L > 15\text{mm}$	NG	

* Visual inspection distance: 60cm, 90 degree (same for front/side/back)

Front Appearance Allowance (Including Coating)			
Defect description	Defective Specifications	Allowance	Remarks
Dot Defect (including particles, bubbles, pits...etc.)	$D \leq 0.7\text{mm}$	Ignored	D=Diameter
	$0.7 < D \leq 1.5\text{mm}$	$N \leq 3$	N=Quantity
	$D > 1.5\text{mm}$	$N \leq 0$	
Linear Defect (including scratches, fluff, particles)	$W \leq 0.2\text{mm}, L \leq 15\text{mm}$	Ignored	W=Width, L=Length
	$0.2 < W \leq 0.7\text{mm}, L \leq 15\text{mm}$	$N \leq 1$	
	$W > 0.7\text{mm}$ or $L > 15\text{mm}$	NG	

Side / Back Appearance Allowance (Including Coating)			
Defect description	Defective Specifications	Allowance	Remarks
Dot Defect (including particles, bubbles, pits...etc.)	$D \leq 1.5\text{mm}$	Ignored	D=Diameter
	$1.5 < D \leq 3\text{mm}$	$N \leq 8$	N=Quantity
	$D > 3\text{mm}$	$N \leq 2$	
Linear Defect (including scratches, fluff, particles)	$W \leq 0.8\text{mm}, L \leq 15\text{mm}$	Ignored	W=Width, L=Length
	$0.8 < W \leq 1.5\text{mm}, L \leq 15\text{mm}$	$N \leq 5$	
	$W > 1.5\text{mm}$ or $L > 15\text{mm}$	NG	

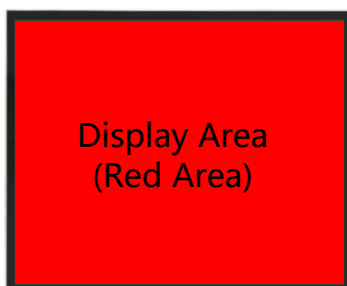

Display Area
(Red Area)



Front Appearance (Red Area)



Back Appearance