

Product Specifications

Customer	
Model	NTAP320-2-S5 V600
Model No.	NTAP320<u>XX</u><u>2XX</u>-S5A54FB-<u>XXX</u>A-600

* X = A~Z, 0~9 (Depends on Options.)



Records of Revision			
Vision	Modifying	Old Description	New Description
v2512.1	Preliminary specification		

Nextech AP Series 32" Android All-in-one Touch PC

NTAP320-2-S5 V600

Features

- ★ 32 inch, 1920x1080 (FHD) Resolution
- ★ Wide Viewing Angle (178°/178°)
- ★ Rock Chip ARM Cortex A55 RK3568 Quad-Core 2.0GHz CPU
- ★ On Board DDR4 4G Memory
- ★ On Board 32 Flash ROM
- ★ Micro SD Card Slot x1
- ★ Android 11
- ★ Narrow Bezel, True Flat Projected Capacitive Touch Screen
- ★ 7H Hardness Tempered Cover Glass
- ★ 10 points Multi-touch, Supports NEXTECH Dedicated Stylus
- ★ Metal Cabinet with Diverse Combine Options
- ★ Made in Taiwan, 3 Years Warranty
- ★ Optional High Brightness 2500nits, for Outdoor Environment
- ★ Optional AG Coating/Anti-UV/Antibacterial/Privacy Filter Surface Treatment



PSE



BSMI



RoHS



CE



ISO9001



FCC



Desktop Stand



Open-frame Brackets

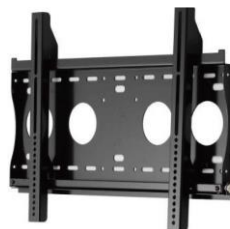

Wall Mounting



Cart



KIOSK Cabinet

System Specifications

CPU	Rock Chip ARM Cortex A55 RK3568 Quad-Core 2.0GHz
Memory	DDR4 4G
Storage	32G Flash ROM
Sound Chip	Realtek Audio HDA Codec
Physical Network	Realtek GbE LAN Chip (RJ45, 10/100/1000 Mbps)
Wireless Network	Wi Fi 2.4/5GHz and Bluetooth 4.2 (support BLE)
OS	Android 11

Display Specifications

Screen Diagonal	32 inch	Display Mode	Normally Black
Display Area	698x392.85 mm	Response Time	8 msec.
Resolution	1920x1080 (FHD)	Backlight Unit	LED (white LED)
Contrast Ratio	4000:1	Viewing Angle (L/R, U/D)	178°/178° (CR=10)
Display Ratio	16:9	Backlight Lifetime	>50,000 小時
Support Colors	16.7M Colors	Operating Temp.	0~50°C
Pixel Pitch	0.3637x0.3637 mm	Storage Temp.	-20~60°C

Display Options

Brightness			
	Brightness	Environment	Model Name
Standard	500nits	General (Indoor)	NTAP320 <u>N</u> X2XX-S5A54FB- <u>XXXA</u> -600
Option 1	1500nits	Outdoor Environment	NTAP320 <u>H</u> X3XX-S5A54FB- <u>XXFA</u> -600 *
Option 2	2500nits	Sunlight Readable	NTAP320 <u>H</u> X4XX-S5A54FB- <u>XXFA</u> -600 *

* Check the data sheets: [NTAP320-3](#), [NTAP320-4](#)

Touch Options

Touch Screen		
	Description	Model Name
Standard	Projected Capacitive Touch	NTAP320X<u>P</u>2XX-S5A54FB-<u>XXXA</u>-600
Option	Non-Touch	NTAP320X <u>0</u> 2XX-S5A54FB- <u>XXXA</u> -600

Projected Capacitive Touch

Touch Technology	Projected Capacitive	Thickness of Cover Lens	3.0±0.2mm
Allowed Touch Points	10 points	Hardness of Cover Lens	7H
Transparency	≥87%	IK Ratings	IK07
Accuracy	99.00%		

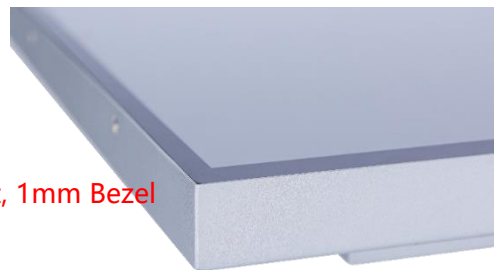

* True Flat, 1mm Bezel

Surface Treatment		
	Description	Model Name
Standard	(none)	NTAP320XX2<u>00</u>-S5A54FB-<u>XXXA</u>-600
Option 1	Anti-Glare&Anti-UV Coating	NTAP320XX2 <u>GG</u> -S5A54FB- <u>XXXA</u> -600
Option 2	Antibacterial (AB Film)	NTAP320XX2 <u>AB</u> -S5A54FB- <u>XXXA</u> -600
Option 3	Anti-Spy (AS Film)	NTAP320XX2 <u>SF</u> -S5A54FB- <u>XXXA</u> -600

Passive Stylus Pen (Option)	
Technology	Passive High Sensitive Knitted Wire Mesh Fiber Tip
Size of tip	6mm
Magnetic Attachment	Yes

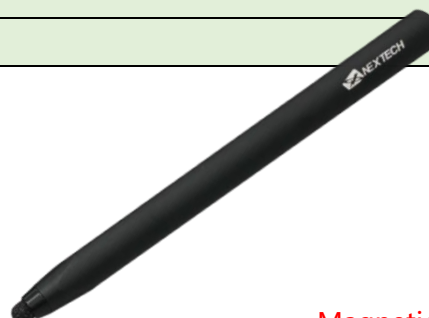

Magnetic Attachment >

System Options

Material of Cabinet		
	Description	Model Name
Standard	SECC	NTAP320XX2XX-S5A54FB-<u>S</u>XXA-600
Option 1	Stainless Steel	NTAP320XX2XX-S5A54FB- <u>L</u> XXA-600
Option 2	Aluminum	NTAP320XX2XX-S5A54FB- <u>A</u> XXA-600

Color of Cabinet		
	Description	Model Name
Standard	Silver	NTAP320XX2XX-S5A54FB-<u>X</u>SXA-600
Option 1	White	NTAP320XX2XX-S5A54FB- <u>X</u> WXA-600
Option 2	Black	NTAP320XX2XX-S5A54FB- <u>X</u> BXA-600
Options	Other Colors	NTAP320XX2XX-S5A54FB- <u>X</u> XXA-600

* X = A~Z, 0~9 (Depends on Color)

Cooling Fan		
	Description	Model Name
Standard	Fanless	NTAP320XX2XX-S5A54FB-<u>XX</u>0A-600
Option	7 Blades/4000r.p.m/28.3dB	NTAP320XX2XX-S5A54FB- <u>XX</u> FA-600

Input /Output System

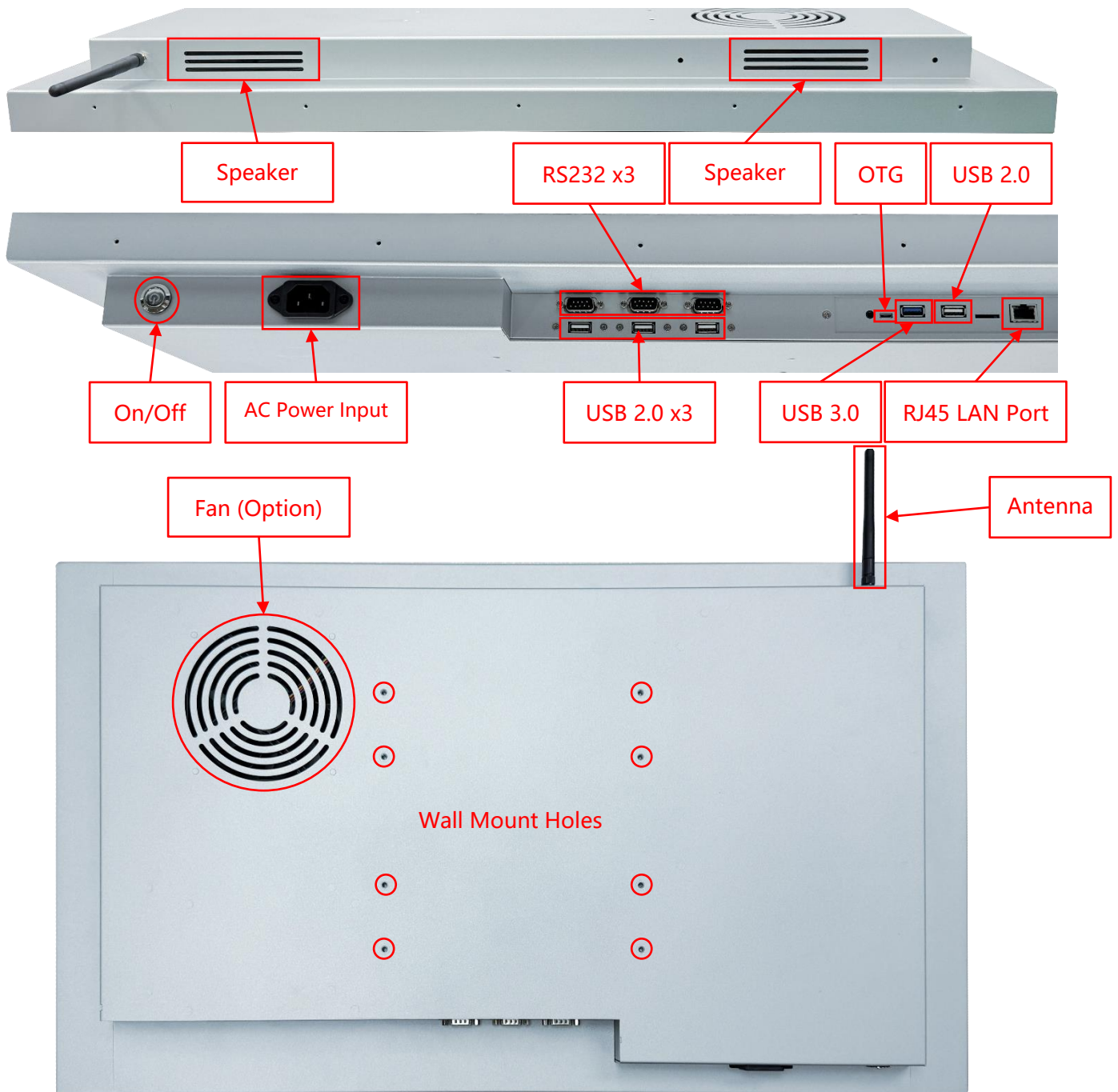

Input / Output	Connectors	Input / Output	Connectors
AC Power Input	1	Micro SD Card Slot	1
USB 2.0	4	LAN (RJ45)	1
USB 3.0	1	Wi-Fi/Bluetooth & Antenna	1
RS232	3	Speakers	10W x2

Front Cover (Option)

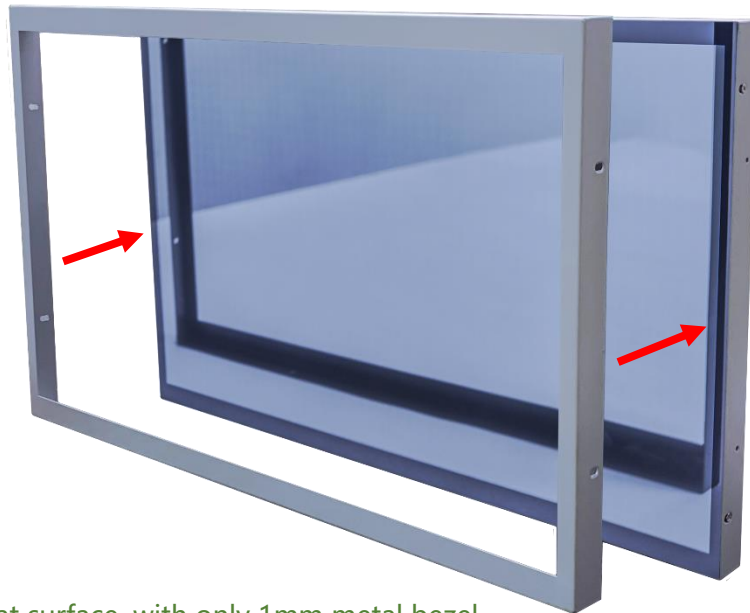

The standard **NTAP320** is true flat surface, with only 1mm metal bezel. To protect the corners of the touch screen, the **Front Cover** can be added.

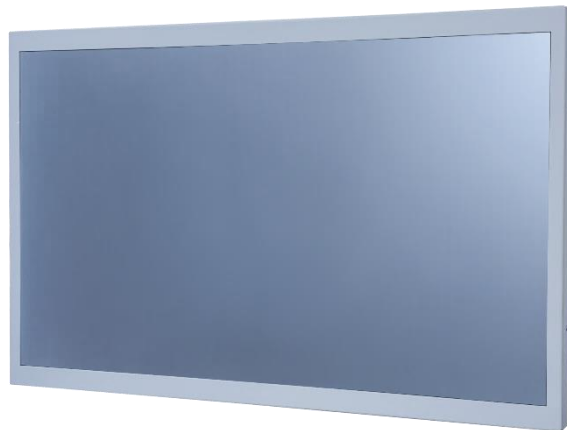

The watertight gasket can be added between the **Front Cover** and **NTAP320**. It complies **IP65** on front.

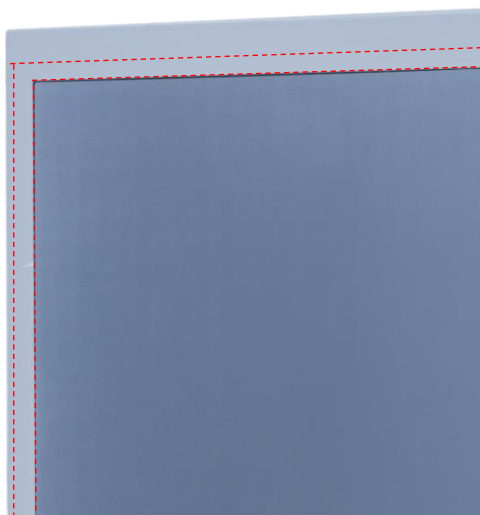

Open-frame Brackets (Option)

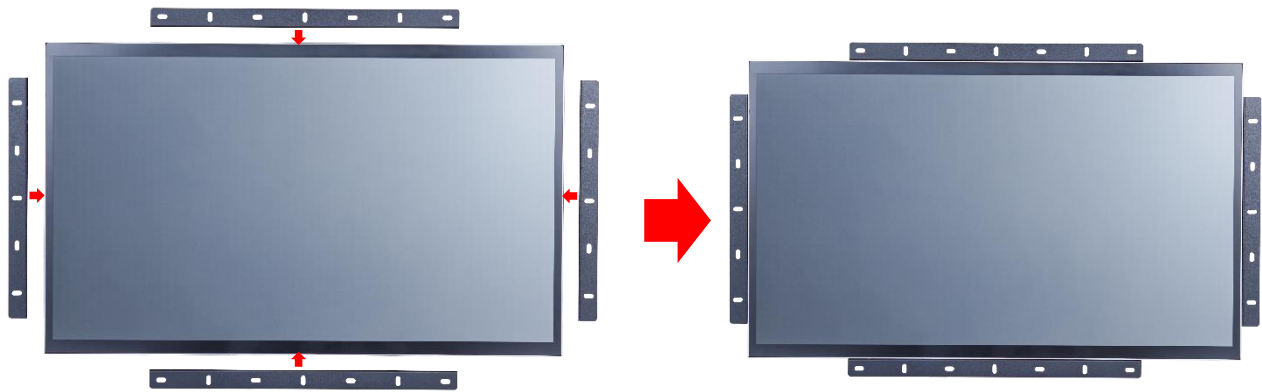

Dimension for Installing with Open-frame Brackets

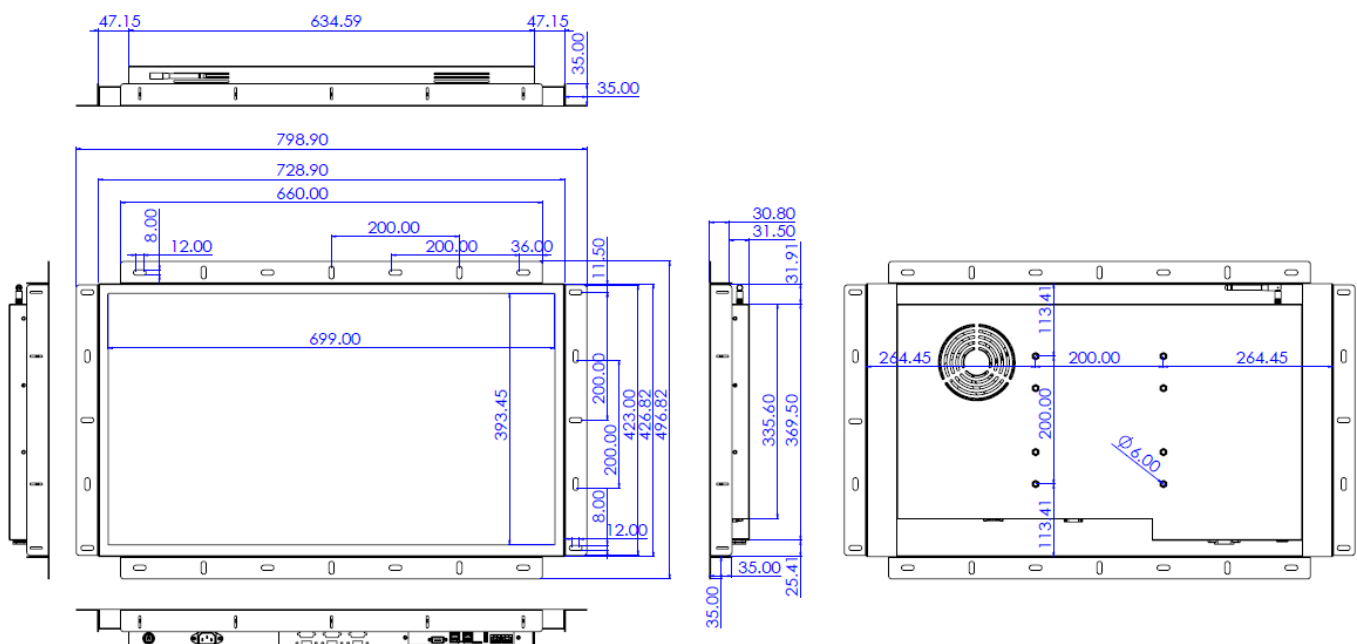

Desktop Stand (Option)

Item	T Stand	Part No.	DST-1B007
Mounting Pattern	200x100/100x100/75x75 mm	Dimension (WxHxD)	508(W)x307(D)x470(H) mm
Material	Steel/Plastic/Aluminum	Net Weight	2.44 KG
Tilt (Hinge)	+/-15°	Support Max. Weight	15 KG

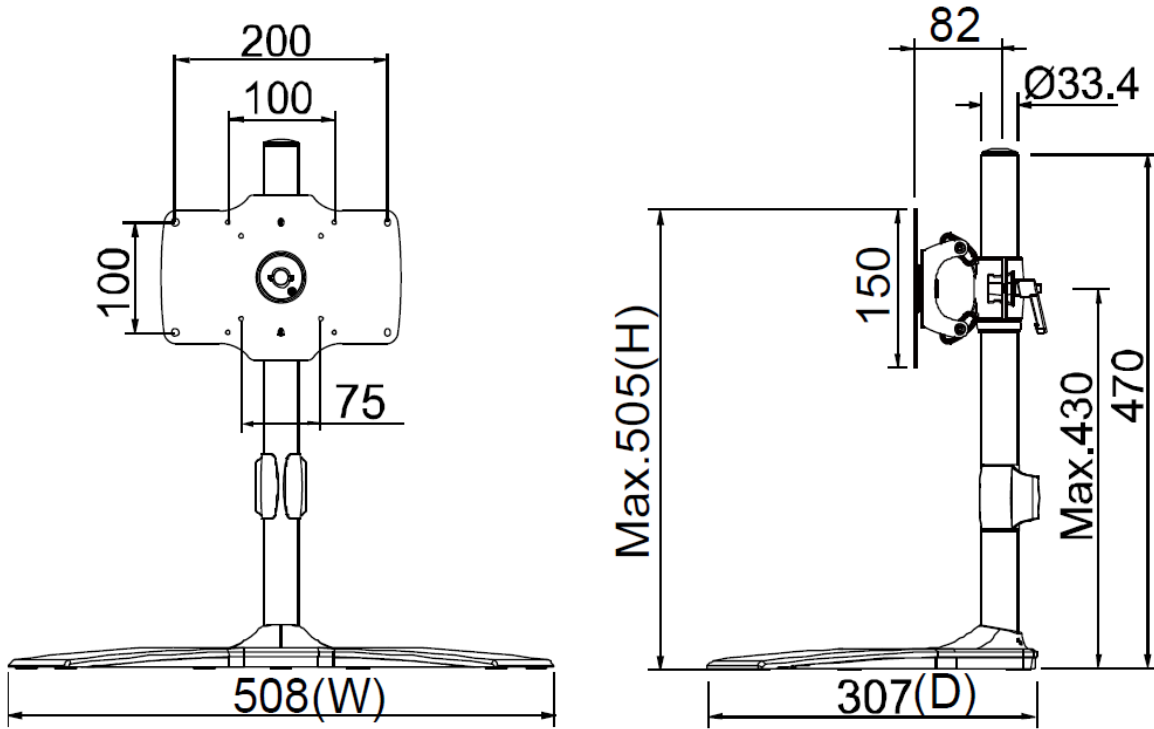

Wall Mount Bracket (Option)

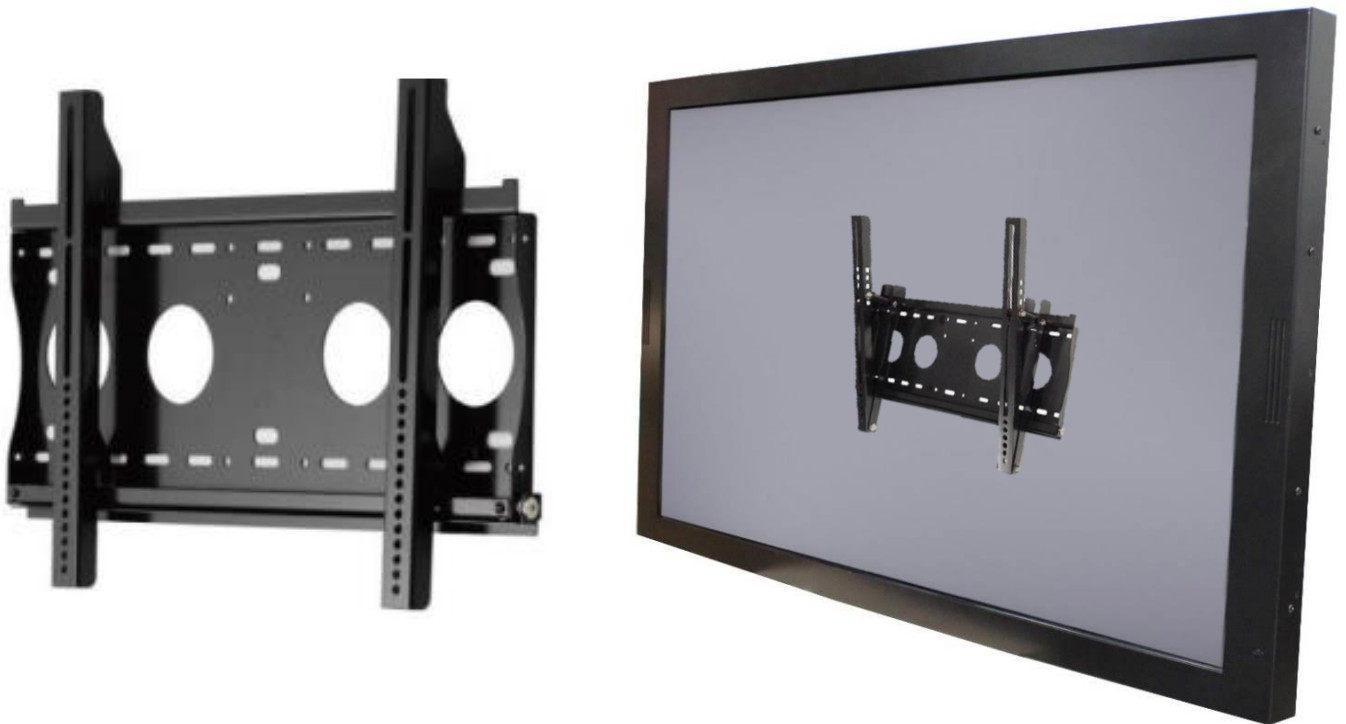

Part No.	WMB-B001		
Mounting Pattern	Max. 400x450 mm	Mounting Pattern	Max. 400x450 mm
Material	SECC	Material	SECC
Tilt (Hinge)	0°/5°/10°/13°/15°	Tilt (Hinge)	0°/5°/10°/13°/15°
Screw Type	M4/M5/M6/M8	Screw Type	M4/M5/M6/M8

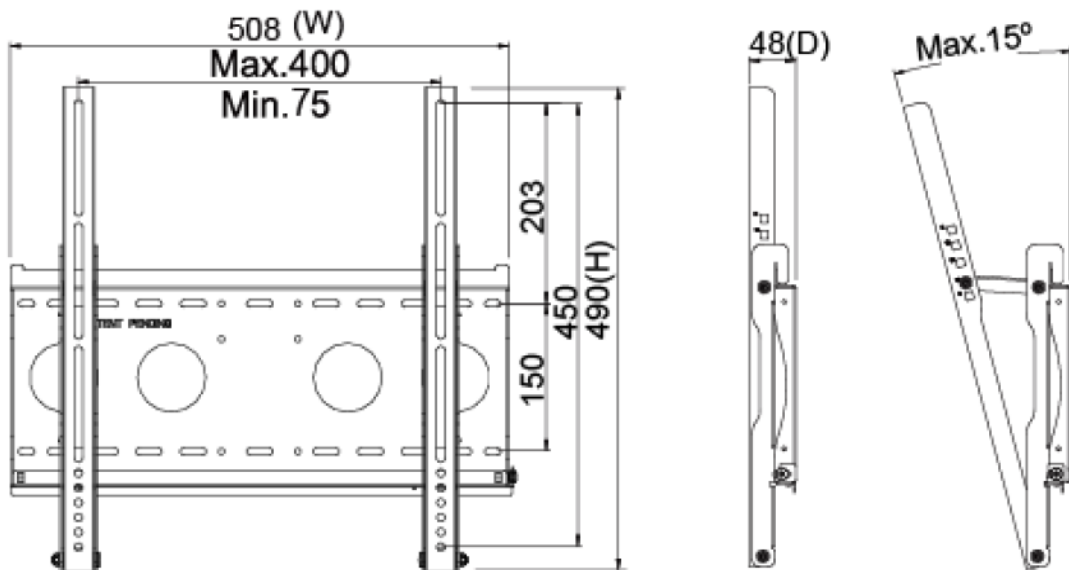

Nextech AP Series 32" Android All-in-one Touch PC

NTAP320-2-S5 V600

Cart (Option)



Net Weight	28.4 KG
Power System	AC 200~240V 50/60Hz
User Interface	Button (up/down)
Packaged Dimension	W1160xD833xH1727 mm
Screw Type	M4/M5/M6/M8
Material	Aluminum/Plastic/Steel
Max. Mount Pattern	800x600mm
Max. Weight Load	80 KG
Caster	4 (front 2 braking)
Height Adjust Range	455 mm
RoHS/REACH	Yes

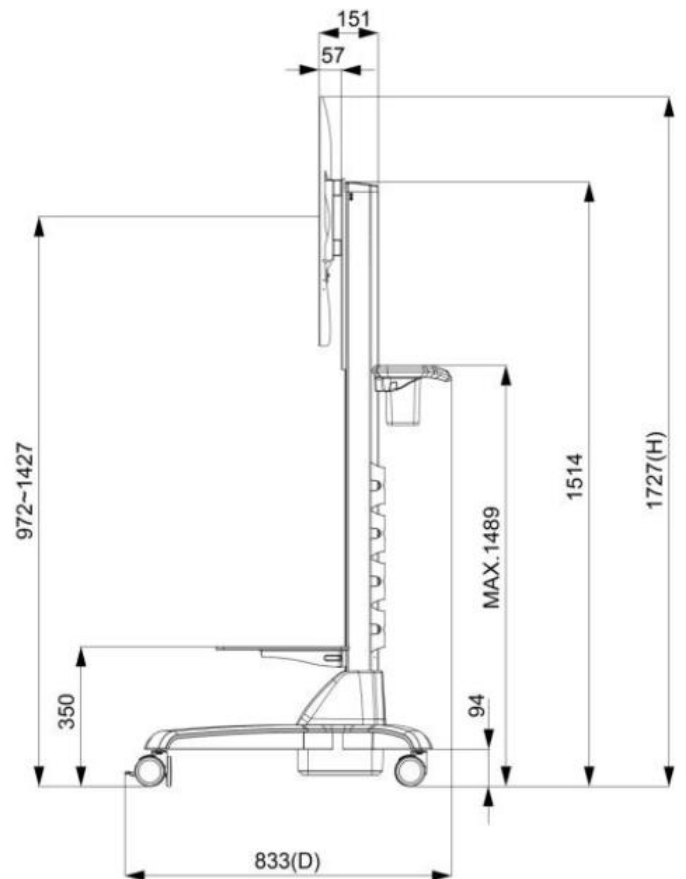
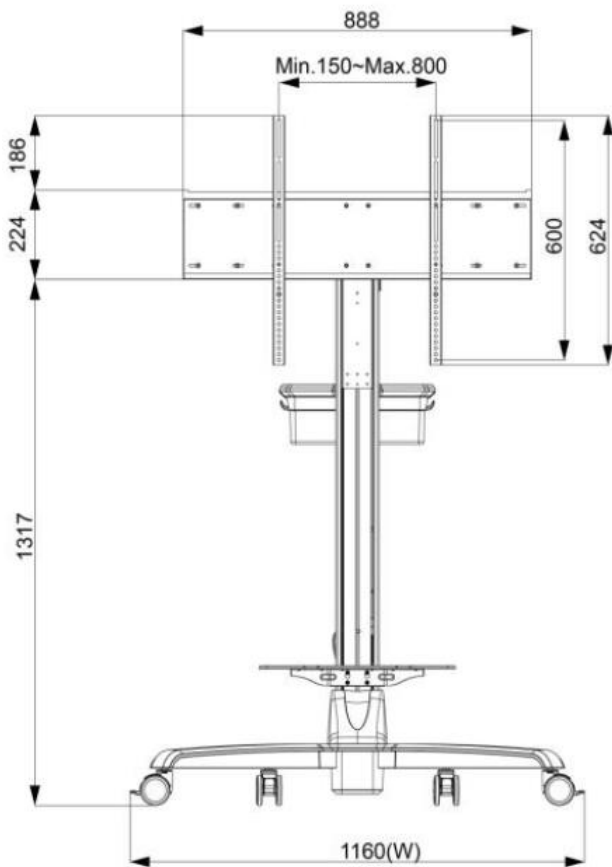

KIOSK Cabinet (Option)



Material	SECC
Caster	4 (front 2 braking)
Ingress Protection	Front IP65
Power Socket	None (Wire Hole Reserved)



Packing Information



Dimensions of Carton	105x24x68 CM
Net Weight	≤ 13.2 KG
Gross Weight	≤ 16.6 KG